

FULL HEIGHT TURNSTILE ME402-3

ME402-3 Full high turnstile is also called a rotary turnstile door which are floor-to-ceiling turnstiles with mechanical rotating barriers. It is the highest safety solution compared with other turnstile gates. Because it can prevent climb over attempts, which is suitable for unmanned areas. The turnstile is used in football stadiums, warehouses, factories, offices, stadiums, perimeters, airports, research labs etc.

The mechanism comes with a hydraulic damper, which can reduce the noise when operating. There is a fire alarm interface; when in an emergency, the gate will be free egress. Full height turnstiles can be used for one-way or bi-directional passage depending on control requirements. Further, the turnstiles can be fitted with turnstile safety sleeves for ease of use, protection, and insulation.

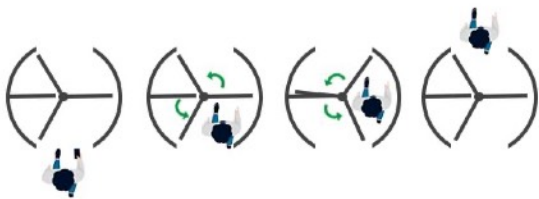

On receiving a signal from the access control system or remote control, the mechanism unlocks and the arms can be pushed to pass through the gate in the authorized direction. It prevents two passages at one time, and if an unauthorized person attempts to enter from the opposite direction, the in-built locking mechanism stops any attempt to reverse the rotation.



PASSING SPEED



BI-DIRECTION



POWER SUPPLY



ANTI-TAILGATING



PROTECTIVE LEVEL

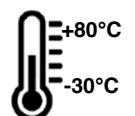

TEMPERATURE RANGE

Dimension	2400*1350*2310mm (7.87*4.43*7.58ft) (standard)
Passage Width	650mm (2.13ft) (standard)
Passage Height	2000mm (63.56ft) (standard)
Frame Material	304 stainless steel (standard), 316 stainless steel, Powder coated
Power Supply	100V-240V 50/60Hz
Drive Solenoid	DC 24V
Open Signal	Passive Relay (Dry Contact)
Communication	RS485
Working Direction	Bi-directional(standard), Unidirectional
Fire/Emergency	Free to exit
Working Temperature	-30°C ~ 80°C
Working Environment	Indoor and Outdoor
Relative Humidity	95% Maximum

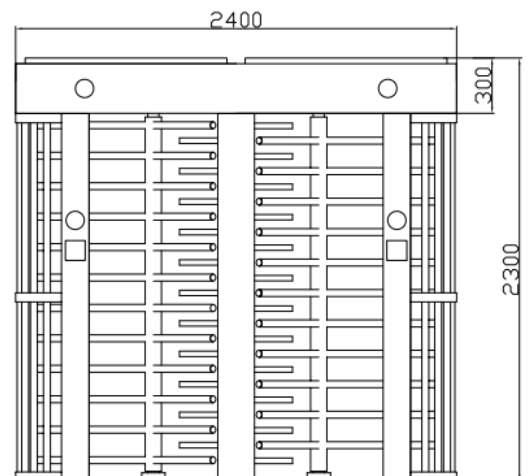
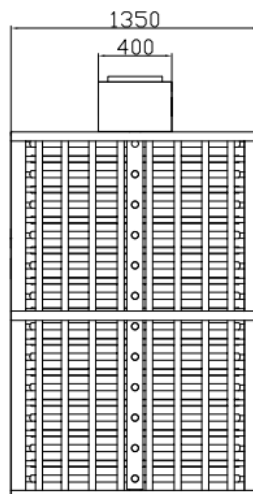
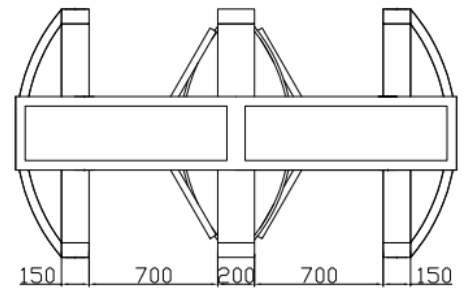
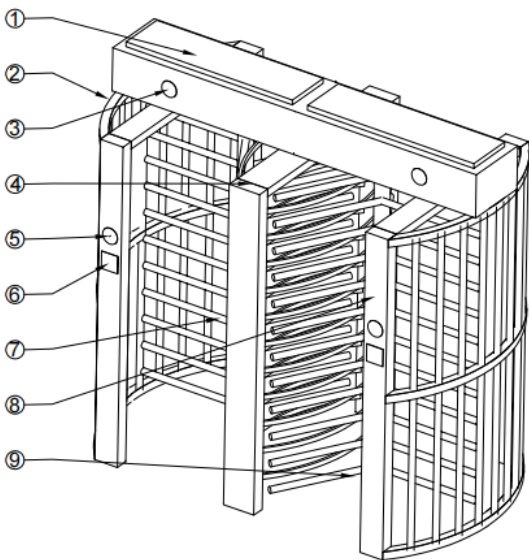

- ① Top Lid
- ② Access Way Wall
- ③ LED Indicator
- ④ Central Enclosure
- ⑤ LED Indicator
- ⑥ Card Reader or Scanner Location
- ⑦ Rotor with Barrier Rods
- ⑧ Access Way Wall
- ⑨ Base

- The mechanism comes with mechanical anti-passback function.
- Equipped with a hydraulic shock absorber for less noise during operation.
- Y rotor mechanism: If rotor revolves to the angle 60° and it is blocked from reverse rotation.
- The full turnstile will lock after 5 seconds if there is open signal but no one pass. (The time can be adjusted in the control board)
- Automatic opening after emergency fire signal input.
- Normal open can be also controlled via control board or manual.
- Full turnstiles will automatically open when power failure.
- Controller with a display, more convenient to set parameters.

Our gates come with relay signals and RS485/RS232 interfaces. You can use your own access control system, or we can provide a complete access control system to you.



Remote control



RFID card



QR code/ barcode



Counter



Face recognition



Fingerprint recognition



Coin/card collection



Button

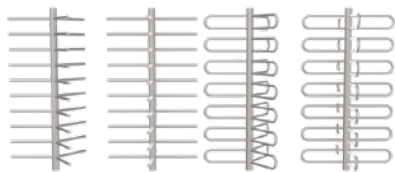

Various barrier rods are available.



Other colors available, RAL or RGB required.



Black Gray Green Blue Red



With roof



With mounting base

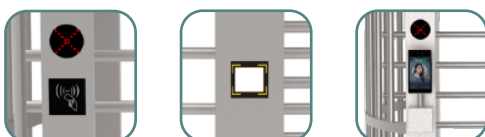

Cutouts can be customized to fit any reader.

- Dimension: Can be made according to the client's site.
- Barrier rod: Straight barrier rod to U-shape barrier rod; X rotor to Y rotor (some models).

- Material: 304 stainless steel to 316 stainless steel (wet environment), or iron with powder coated. The outer paint finish can be colour coded to match the local environment.

- Roof and lights can be added.
- Mounting base can be added.
- Cutouts can be customized to fit any reader.
- LOGO can be customized.

- Customized 3D drawings are available based on the site photos.

- OEM& ODM service is available > Please check with sales for customization fees.

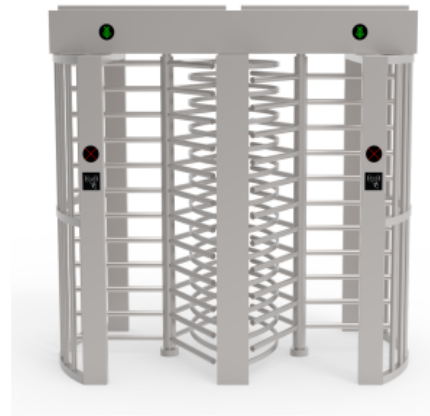
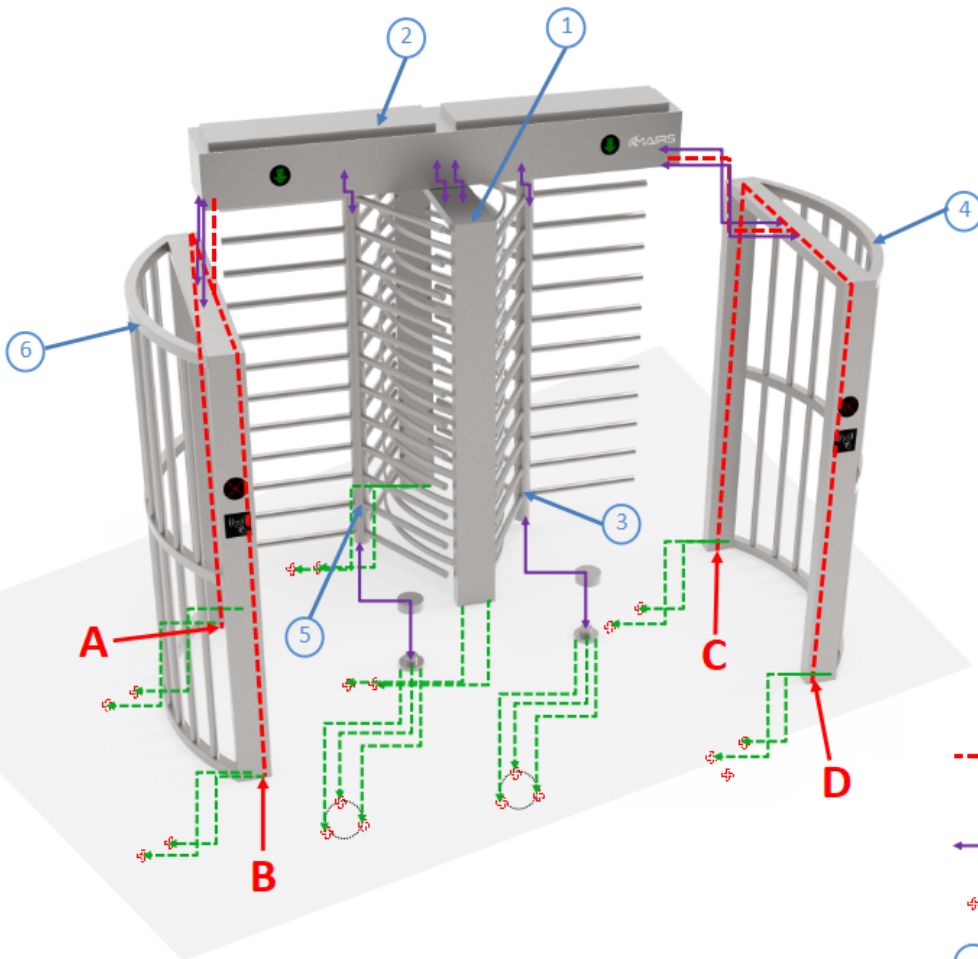

Label description

- The power cable and LAN can go to the gate from A or B or C or D per your project requirement
- Fixing hole location
- ⊕ Expansion screw
- Assemble sequence number

